

GLS™ TPE

Table of Contents

Introduction	1
Overmolding	2
Material Selection	4
Part and Mold Design	6
Material Handling and Preparation	17
TPE Injection Molding	18
Overmolding Processing – Maximizing Adhesion	21
TPE Injection Molding Troubleshooting	23
TPE Overmolding Troubleshooting	28
Index	30

Introduction

Avient is the recognized leader in the overmolding of thermoplastic elastomers (TPEs). Our GLS™ overmold TPEs have excellent adhesion to a wide variety of substrates, from polyolefins, such as polypropylene and polyethylene, to engineering resins, such as PC, ABS, acetal and nylon.

Avient has developed several innovative technologies that have continued to set the standard in overmolding. Our overmolding product line includes a variety of TPE technologies designed to deliver optimum adhesion to many engineering plastics in both insert and two-shot molding processes.

When working with Avient, you get the benefit of a world-class application development team spanning:

- Component design knowledge.
- Valuable tooling input.
- Creativity in molding process knowledge and material combinations.
- Formulation development to meet specific application requirements.

This GLS TPE Overmolding Guide is a comprehensive discussion of issues that are critical to achieving high quality overmolded products. This guide is a compilation of more than 25 years of experience in the development, design and processing of overmolding TPEs, based on contributions from a variety of Avient and industry sources.

Overmolding

Overmolding is the injection molding process where one material (usually a TPE) is molded onto a second material (typically a rigid plastic). If properly selected, the overmolded TPE will form a strong bond with the plastic that is maintained in the end-use environment. The use of primers or adhesives is no longer required to achieve an optimum bond between the two materials.

Overmolding can be used to enhance many features of product designs, including:

Safety	Ergonomics	Product Functionality
<ul style="list-style-type: none">• Improved grip in dry and wet environments.• Vibration damping.	<ul style="list-style-type: none">• Increase in comfort level.	<ul style="list-style-type: none">• Water resistant seal.• Sound absorption.• Electrical insulation.

Overmolding Process Types

Two injection molding processes dominate the manufacture of overmolded products: insert molding and multi-shot injection molding.

Insert Molding

The most widely used process is insert molding, where a pre-molded insert is placed into a mold and the TPE is shot directly over it (**Figure 1**). For molders, the advantage of insert molding is that conventional single shot IM machines can be used (new machinery expenditures are not necessary), and the tooling costs associated with insert molding are lower than with multi-shot processing.

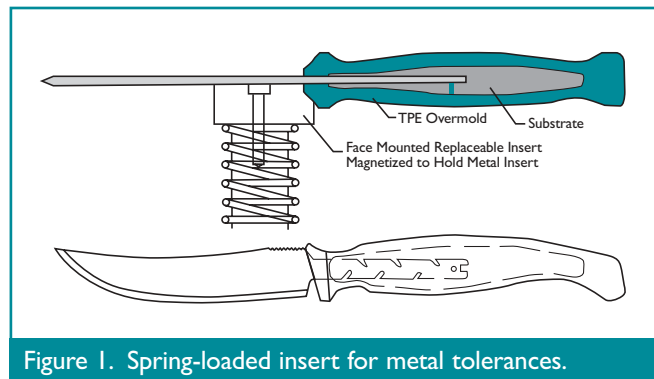

Multiple Material Molding

Multiple material, also known as two-shot (or multi-shot), molding requires a special injection molding machine that is equipped with two or more barrels, allowing two (or more) materials to be shot into the same mold during the same molding cycle.

A molder will choose multi-shot molding to reduce cycle times, achieve superior part quality and reduce labor costs.

Overmolding Process Selection

A processor will weigh numerous factors when choosing the appropriate manufacturing method for the application. The most critical decision factors are production scale economics, local labor costs, available equipment and the materials selected.

Generally, insert molding is the process of choice when annual production volumes and local labor costs are low. For higher volume production programs (over 250,000 units annually) or areas with increased labor costs, multi-shot molding operations are the method of choice.

With any overmolding application, the challenge is in achieving maximum adhesion between the TPE and the substrate. For some overmolding TPEs, there may be a significant difference in bond strength between multi-shot and insert molding. Even if an excellent bond is achieved with two-shot molding, the same material may have poor bond strength when insert molded. Thus, a complete understanding of the TPEs, engineering plastics, and associated details about molding these materials is essential to produce high-quality finished products.

Material Selection

The most common word used to describe a soft touch overmold is “feel” — but the term itself is very difficult to describe. When a designer wants the product to feel “grippy” or “squishy”, what exactly does this mean in terms of material properties?

Basically, the “feel” of a soft touch overmold is dependent upon a combination of material properties (hardness, modulus, and coefficient of friction), texture and the TPE wall thickness.

Thickness Effects

When choosing a soft touch TPE, designers usually ask for the softest material available. What they do not know is that the soft durometer of a TPE adds little value to the concept of “cushion” when the thickness of the TPE is below a certain point (typically > 0.040 ”). This means that the thinner the TPE overmold, the harder it will feel — the actual hardness effect is dependent on the thickness of the TPE overmold. One way of getting around this issue is to incorporate multiple ribs that are placed closely together to create the perception of thickness without using a large amount of material. This technique is used often in personal care grips.

Hardness vs. Modulus

One common myth in the TPE industry is that the durometer (or hardness) of a material is directly related to its flexibility. This is not always true; for example, a 65 Shore A SEBS material is much more flexible than a 65 Shore A TPU. Instead of using Shore Hardness, a more suitable measure of flexibility is the flexural modulus, which measures a material’s resistance to bending. A higher flexural modulus typically means that a material will feel more stiff and unyielding.

Coefficient of Friction

When two surfaces are dragged flat against each other, the resulting resistance is characterized as friction. The coefficient of friction (COF) characterizes the degree of force required to move one surface across another — either from a complete stop (static friction) or when the surface is already moving (kinetic friction). Typically, TPEs are described as rubbery or “grippy” — Avient has the capability to customize the COF according to the requirements of the application — from smooth and silky to extremely tacky.

One area that product designers often misunderstand is the relationship between durometer and COF. Most believe that the softer the TPE, the greater the COF — this is a very general statement and is not true in all cases. There are several GLS products in the 40 Shore A Hardness range that have varying COFs.

For assistance in choosing the material with the optimum COF for an application, please contact your Avient representative.

Adhesion Requirements

When selecting a TPE for an overmolding application, the substrate type should be considered. Not all GLS TPEs will bond to all types of substrates; for example, a Dynaflex™ TPE that bonds to polypropylene (PP) will not adhere to polycarbonate (PC).

Avient offers a diverse product line of TPE formulations and alloys for overmolding onto a variety of substrates. Most Dynaflex™, Versaflex™, Versalloy™ and OnFlex™ materials are suitable for two-shot or insert molding with a polypropylene (PP) as the insert or substrate.

Avient's GLS Overmolding TPEs (Versaflex™ and Versollan™) are specially formulated to bond to a variety of thermoplastics, including:

- Polycarbonate (PC)
- Acrylonitrile Butadiene Styrene (ABS)
- PC/ABS
- Standard and Modified* Nylon 6, Nylon 6/6, Nylon 6,6,6
- Copolyester
- Polystyrene (PS)
- High Impact Polystyrene (HIPS)
- PC/PETG
- Acetal (POM)
- Polyphenylene oxide (PPO)
- Alloys or blends of the above

**Glass-filled, impact-modified, and/or heat-stabilized versions.*

For more information regarding specific overmolding TPEs and their corresponding substrate materials, please refer to the Avient's Thermoplastic Elastomers Product Selector Guide.

Part and Mold Design

Part Design Basics

- The wall thickness of the substrate and overmold should be as uniform as possible to obtain the best molding cycle time. Wall thicknesses ranging from 0.060" to 0.120" (1.5 mm-3 mm) will ensure good bonding in most overmolding applications.
- If the part requires the use of thick TPE sections, they should be cored out to minimize shrinkage problems, reduce the part weight and lower cycle time.
- Transitions between wall thickness should be gradual to reduce flow problems, such as back fills and gas traps.
- The use of radii (0.020" or 0.5 mm minimum) in sharp corners helps reduce localized stresses.
- Deep, unventable blind pockets or ribs should be avoided.
- Long draws should have a 3-5° draft per side to aid component ejection.
- Properly designed deep undercuts are possible with GLS TPEs (<60 A Hardness) if:
 - The part does not have sharp corners.
 - An advancing core is used when the mold opens.
 - The elastomer is allowed to deflect as it is ejected.
- The TPE thickness should be less than or equal to the thickness of the substrate to prevent warpage; this is especially critical for long, flat geometries.

Flow Length (L) and Wall Thickness (T)

There are two main factors that affect the maximum achievable flow length for a specific TPE: the individual TPE flow characteristics and the process conditions used in the overmolding process.

The flow characteristics of a TPE can be quantified by performing a spiral flow test. Spiral flow testing, which has been traditionally used for thermoplastics, provides the processor with a comparative analysis of a material's ability to fill a part. The spiral flow lengths of various GLS product lines at two injection speeds (3 in/sec and 5 in/sec) are summarized in **Table 1**. For applications with higher bond strength requirements, shorter flow lengths are advisable. Alternatively, mechanical interlocks are highly recommended.

Table 1. Typical Flow lengths achievable with GLS TPEs*.

Series	Flow Length, inches (cm)	
	Injection Velocity, 3 in/s (8 cm/s)	Injection velocity, 5 in/s (13 cm/s)
Dynaflex™ D	13-15 (33-38)	18-20 (46-51)
Dynaflex™ G	12-22 (30-56)	18-30 (46-70)
Versaflex™	9-16 (23-41)	13-26 (33-66)
Versalloy™	18-20 (46-51)	30-32 (76-81)
Versollan™	12-17 (30-43)	19-22 (48-56)

**Spiral flow tests performed using a 0.0625" (1.6mm) thick, 0.375" (9.5mm) wide channel at 400°F (204°C).*

Shrinkage

Due to the wide variety of chemistries of GLS overmolding TPEs, their shrinkage characteristics can vary significantly. **Table 2** summarizes general shrinkage ranges for the various GLS product families. Typical shrinkage values for specific GLS products are located on the individual technical data sheet.

It should be noted that these shrinkage values are guidelines only; the shrinkage of a material is extremely dependent on the material chosen, the part/mold design, and the processing conditions used to mold the part. The shrinkage guidelines provided by Avient are based on a particular specimen geometry (rectangle/plaque) and are determined using a specific type of injection molding machine. As a result, prototyping is highly recommended to assist in predicting the shrinkage effects of a particular GLS TPE.

The following process parameters may increase part shrinkage:

- Mold and melt temperatures that are too high – results in heat sinks due to shrinkage.
- Mold and melt temperatures that are too cold – leads to molded-in stresses that may contribute to part warpage.
- Low pack pressures.

Table 2. Typical shrinkage for GLS TPEs*.

Series	Typical Shrinkage, %	
	Flow Direction	Cross Direction
Dynaflex™	1.5 - 2.1	0.7 - 1.3
Versalloy™	0.9 - 1.3	0.9 - 1.3
Versaflex™	1.1 - 1.7	0.7 - 1.3
Versollan™	1.1 - 2.1	0.5 - 1.0

*These shrinkage values are a range that is representative of all of the TPE grades in a specific product family and should not be used as guidelines for part and mold design. Please refer to Product Data Sheets for specific shrinkage values for each individual grade.

Shut-Off Designs

There are two different types of shut-off designs with the purpose of minimizing flashing of the TPE or reducing the chance of peeling (delamination) of the TPE.

To reduce the opportunity for peeling, the overmold should be designed in accordance with the following guidelines:

- The surface of the TPE should be flush with the non-overmolded section of the substrate.
- The edge of the TPE should be at a deeper level than the surface of the non-overmolded section of the substrate.
- Do not design the TPE edge so that it is even with or over the edge of the part.

To reduce the probability of flashing the mold, the overmold should be designed with the following guidelines:

- Provide a 0.015" – 0.030" (0.38 mm – 0.76 mm) deep groove on the substrate, along the edge of the TPE overmold (Figure 2). The steel should have positive shut-off in the groove. In addition, shrinkage of both the TPE and substrate should be considered.
- When metal or other non-compressible substrates are used, provide springs underneath the steel sections shutting off on the substrate to prevent flashing due to a steel insert with a poor fit.

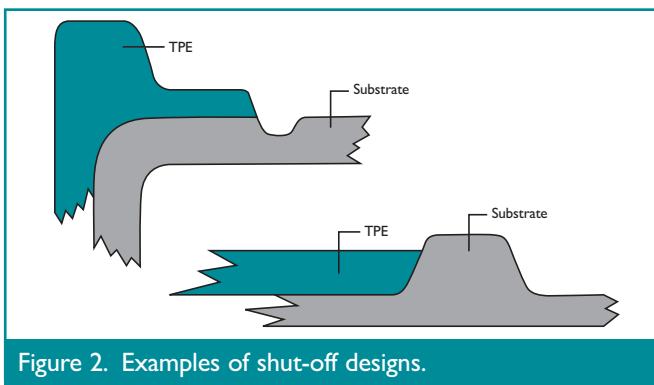

The fundamental bond of GLS TPE over the rigid substrate can be provided by a combination of three basic methods:

- Molecular adhesion.
- Mechanical design techniques.
- Mechanical interlocks.

Figure 3 illustrates three mechanical interlock design options that can be utilized to optimize finished component bond strength.

Utilizing texture on the TPE overmold surface is a good way to impart a unique surface feel to the product and minimize the appearance of surface defects. It should be emphasized that certain textures will lead to a perceived hardness that is higher (or lower) than the actual hardness of the TPE. As a result, the TPE surface texture should be taken into consideration during the material selection phase of the product development process.

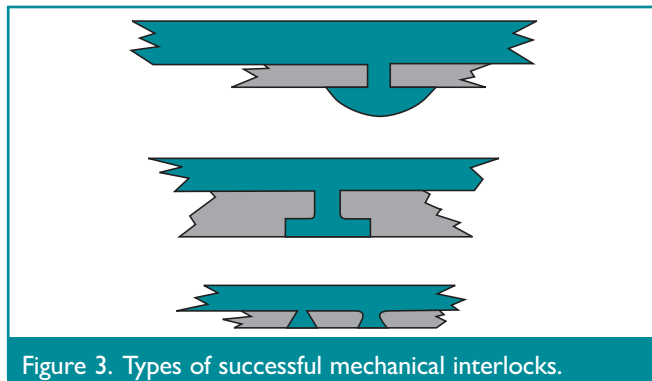

Figure 3. Types of successful mechanical interlocks.

General Mold Design Considerations

- The viscosity of GLS overmolding TPEs is very shear dependent and this should be considered when designing the molds and setting the molding process conditions.
- Start with small TPE injection gates to obtain best TPE fill with minimum cosmetic gate vestige. Large gates should be avoided.
- Gates should be located at the thickest TPE wall section.
- Thought should be given to proper component ejection from the tool to minimize marks on the soft elastomer surface.
- It is critical that adequate cooling is provided to the TPE cavity through proper mold cooling techniques to minimize cycle time.
- Flow ratios should not exceed 150: 1L/T as an absolute maximum for most overmolding applications.

Mold Construction

GLS overmolding TPEs are generally non-abrasive and non-corrosive. The choice of tool steel will depend on the quantity and quality of parts to be produced, the longevity of mold required, and the type of rigid substrate being used in the application. If a reinforced substrate material is used, high hardness abrasion resistant steel will be required. For high volume two-shot or insert molded component production, the initial expense of high quality injection mold tooling is a sound investment. P-20 steel is typically used for mold bases and ejector plate, while H-13 steel is used for cavity and core plates. For applications that require optimum cooling, beryllium copper cores are common.

Most GLS materials replicate the mold surface fairly well. A polished mold is required to produce a glossy surface or optimum clarity. To produce a part with the matte appearance of a thermoset rubber, a rougher mold surface is required. In general, an EDM finish will produce a good surface and good release from the mold. Vapor honing, sand or bead blasting and chemical etching may also be used to produce surfaces with varying degrees of gloss and appearance. To aid in release, the cavity or core may be coated with a release coating, such as PTFE impregnated nickel, after it has been given a sand blast or EDM finish.

Mold Layout and Support

For multi-cavity tools, the cavity layout should be physically balanced. In a balanced system, the TPE melt flows to each cavity in equal times under uniform pressure. An unbalanced runner may result in inconsistent part weights and dimensional variability.

Figures 4 and 5 illustrate examples of balanced and unbalanced runner systems.

In insert molding applications, proper support of the plastic insert is required. Without support, the plastic substrate can deform due to the TPE injection pressure. In extreme cases, the insert will break or the TPE melt will impinge through the plastic insert. Flashing in certain areas of the tool can also result from displacement of the insert within the mold cavity. This is usually not an issue with two-shot molding because the first shot is automatically supported on the “B-half” of the tool.

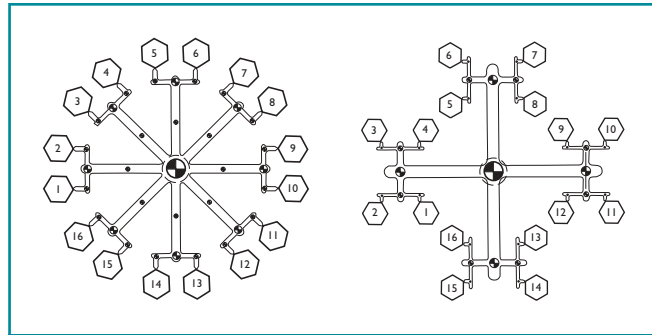

Figure 4. Balanced runner systems.

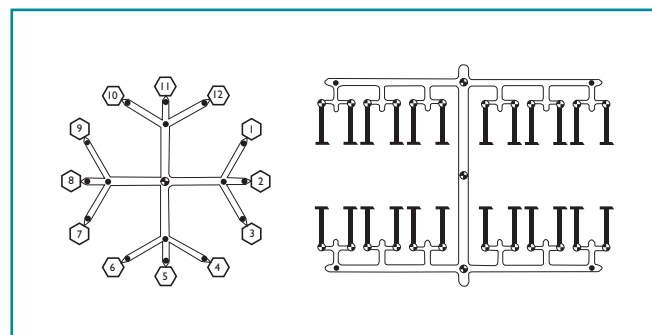

Figure 5. Unbalanced runner systems.

Venting

It has been well-established that the lack of adequate venting is a processing issue for both overmolding production and standard injection molding. If vents are not incorporated into the mold design, the adhesion of the TPE to the substrate can be critically affected in specific areas of the part where air is trapped in the cavity during injection. As the TPE melt is injected into the mold cavity, the air in the cavity must be able to effectively exit the tool. This is usually achieved via the addition of vents at the ends of flow (full peripheral venting is the best solution).

Figure 6 provides an illustration of appropriate venting.

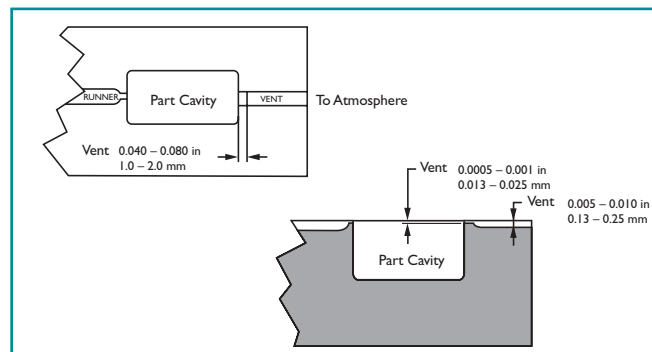

Figure 6. Example of appropriate venting.

TPE Venting Dimensions:

Land Length: Minimum 0.040" or 1 mm (where vent depth is cut).

Depth of Land (vent run out): >0.060" (>1.5 mm)

Vent Depth: 0.0005"–0.001" (0.013 mm – 0.025 mm) deep — 0.00075" (0.019 mm) optimum.

Runner Configuration and Design

For conventional cold runner tools, full-round runners are best because they provide the least resistance to flow and minimize TPE cooling in the runner system. Cooling is minimized because full round runners have less surface area and therefore keep the TPE material molten longer.

The second most efficient runner cross-section is the modified trapezoid. This type of geometry most closely simulates a full round runner, but requires machining in only one tool plate.

Figure 7 illustrates typical runner design guidelines. Runner dimensions rarely exceed 0.3" diameter, even for the primary runner.

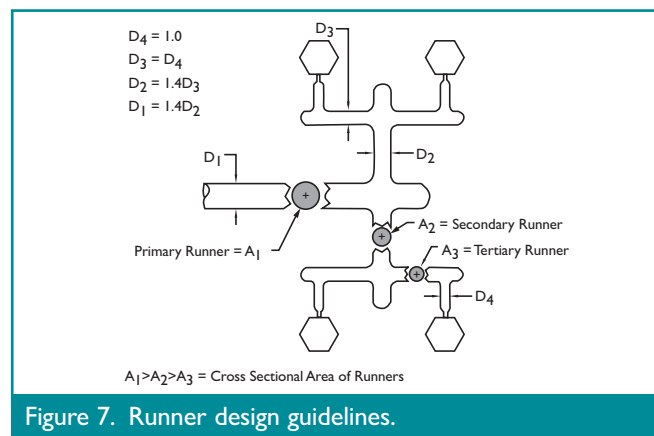

Figure 7. Runner design guidelines.

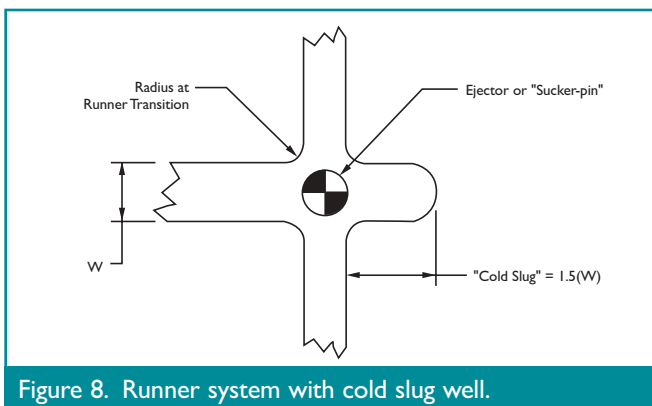

Figure 8. Runner system with cold slug well.

Cold Slug Wells

Cold slug wells should be used at each runner transition (90° turn or division). They should be placed in the direction of the feeding flow front and at the base of the sprue (**Figure 8**). The use of cold slug wells will aid in removal of the solidified leading TPE edge.

Sprue Pullers

Sprue pullers are used to pull the sprue out of the A-half of the tool so that the plastic may be ejected automatically out of the mold using an ejector pin. For GLS materials with hardnesses over 50-90 Shore A, a sprue puller with a Z-type may be used to pull the sprue out.

The sprue puller should be polished, while the sprue and runners should have a rough EDM finish. This would enable the plastic to stick to the sprue puller as it is withdrawn. In the case of softer GLS materials, it may be necessary to use a more aggressive sprue puller such as a pine tree design (**Figure 10**). It is extremely important to position cooling channels close to the sprue puller since this can help the plastic to harden around the puller before it is withdrawn.

In the case of three plate tools, a sucker pin with a simple spherical end is suitable. This would help pull the runners out of the floater plate. A low reverse draft of 10-15° may be added to the sides so as to help form a slight undercut. As stated earlier, it is very important to incorporate channels on either side of the sucker pin. In addition, a rough EDM or sandblast finish should be used for the runners and a polished finish for the sucker pins. This should help the sucker pin to pull the runner out more easily. A more aggressive sucker pin may pull the runners out, however it may be difficult to automatically remove the runners off the sucker pin once the mold is open. Sprue pullers may not be necessary when hot sprues are used.

Gate Design and Location

Most conventional gating types can be used in the molding of GLS TPEs.

The type of gate and the location, relative to the part, can affect the following:

- Part packing.
- Gate removal or vestige.
- Part cosmetic appearance.
- Part dimensions, including substrate warpage.

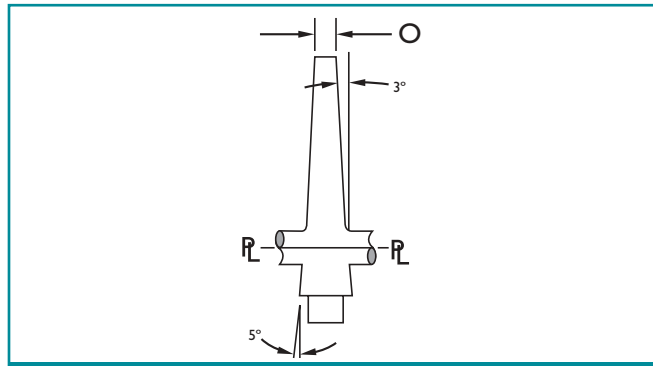

Figure 9. Conventional sprue.

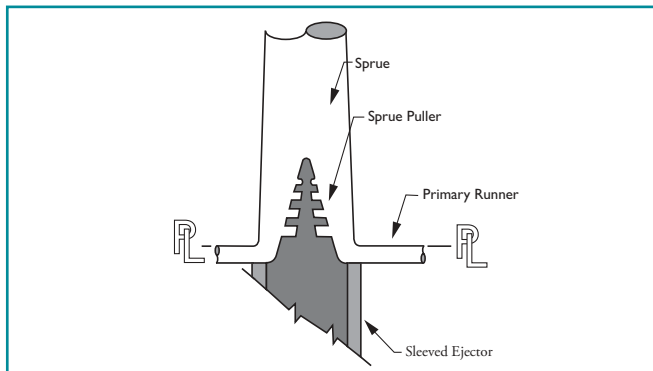

Figure 10. Pine tree sprue puller for soft GLS TPEs. cooling

The type of component gating is dependent on both the finished part and injection mold design. The gate location is critically important; the gate should be located at the thickest section to minimize molded-in stresses. To prevent the chances of jetting, locate the gate in an area where the flow will impinge on a cavity wall. For automatically degating tools, the highly elastic nature of soft TPEs makes gate designs such as submarine gates or three plate tools with self-degating drops more difficult. To assure the gates will break at a specific location, they should have a short land length to create a high stress concentration.

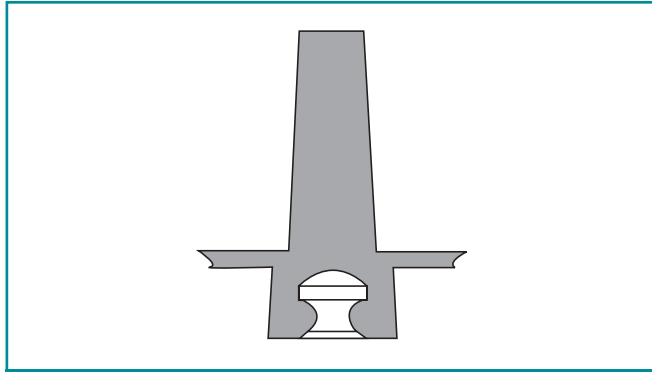

Figure 11. Buttonhead sprue puller for automated removal.

Tab/Edge Gate

Tab and edge gates (Figure 12) most commonly utilize a conventional sprue and cold runner system. They are located along the tool parting line. The part design may use a small undercut where the gate meets the part to minimize gate vestige protruding above the part surface.

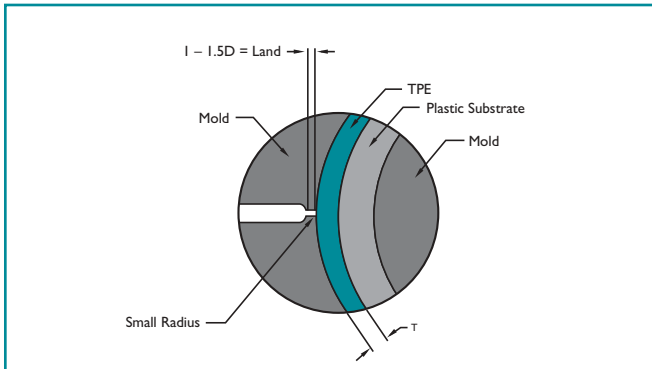

Figure 12. Tab/edge gate.

Advantages of tab and edge gates are ease of:

- Fabrication.
- Modification.
- Maintenance.

For styrenic-based TPEs, the gate depth (D) should be 25-35% of the TPE component's wall thickness at the gate entrance; 35-50% for urethane-based TPEs. Common practice is to start "steel safe", as it is always much easier to enlarge the gate size (no welding required). A good starting point for the gate width should be 1.0-1.5 times the gate depth. The gate area in the mold may be included as a removable insert to facilitate gate maintenance or modification.

Submarine (Tunnel) Gate

Submarine or tunnel gates are self-degating; during part ejection, the molded part and runner are separated by the tool steel. To promote degating, a radius can be located at the end of the sub-gate; typical dimensions are 1.5-2 times the radius of the gate.

Figure 13 shows a typical design of a submarine gate.

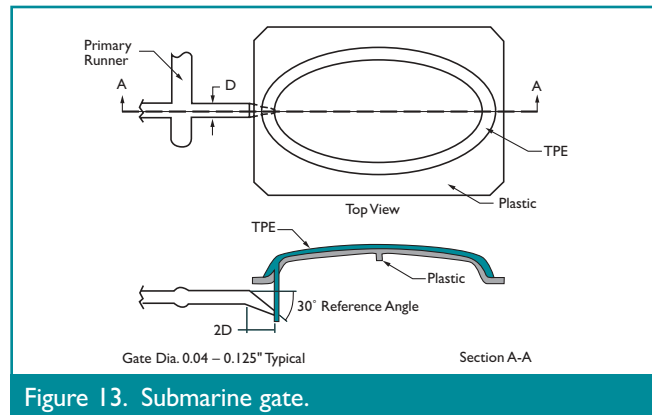

Figure 13. Submarine gate.

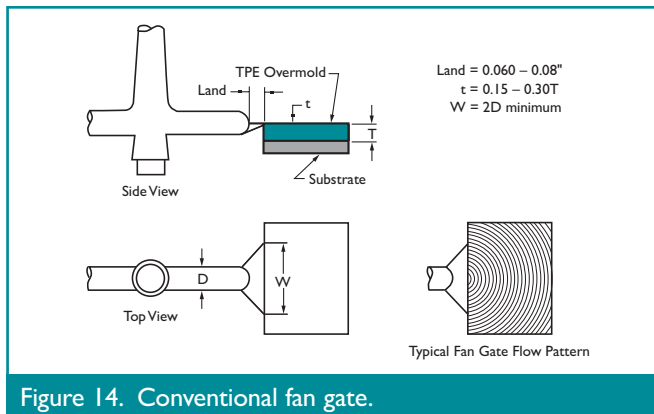

Figure 14. Conventional fan gate.

Fan Gate

A fan gate is a variation of a tab gate (**Figure 14**). The fan gate distributes material into the cavity more evenly than other gate designs. It is normally used in parts that require a high degree of flatness.

Sprue or Direct Gate

Sprue, or direct gating is often used on prototype parts; the cavity is placed directly in line with the center of the sprue. If the product design requires a sprue gate, a hot sprue is preferred over cold because it reduces scrap, decreases cycle time, and allows for easier processing.

Sprue gating is not recommended for production tools or for aesthetic parts due to the potential for “cold-slugs” on the part surface. The sprue will also need to be manually trimmed. If this type of gate is desired, both the sprue length and diameter should be as short and small as possible.

Table 3. Advantages and disadvantages of various gate types.

Gate Type	Advantages	Disadvantages
Edge/Tab/Pin Gate	<ul style="list-style-type: none"> • Appropriate for flat parts. • Easy to machine and modify. 	<ul style="list-style-type: none"> • Post-mold gate/runner removal. • Larger gate vestige.
Submarine Gate	<ul style="list-style-type: none"> • Auto gate removal. • Minimal gate vestige. 	<ul style="list-style-type: none"> • More difficult to machine. • More difficult to extract.
Back Gating (through pin & hole in substrate)	<ul style="list-style-type: none"> • No gate vestige on front side of part. 	<ul style="list-style-type: none"> • More complex. • Post-mold trimming. • Potential surface sink.
Diaphragm Gate	<ul style="list-style-type: none"> • Concentricity. • Appropriate for round parts. • No knit lines. 	<ul style="list-style-type: none"> • Post-molding gate/runner removal. • Scrap.
Pin Gate (3-plate)	<ul style="list-style-type: none"> • Auto gate removal. • Minimal gate vestige. • Localized cooling. 	<ul style="list-style-type: none"> • Requires floater plate. • More scrap. • Higher tool cost.
Valve Gate (hot runner systems)	<ul style="list-style-type: none"> • Minimal gate vestige. • Positive shut-off. • Minimizes post pack. 	<ul style="list-style-type: none"> • High tool cost. • Higher maintenance.

Gate Location Considerations

Locate Gates:

- At the heaviest cross section, to facilitate part packing and minimize voids and sink.
- To ensure a flow path that will yield optimum adhesion.
- To minimize obstructions in the flow path (flowing around cores or pins).
- To minimize jetting (in thin-walled components).
- Where potential residual molded-in stresses around the gate will not affect part function or aesthetics.
- To minimize flow marks in critical cosmetic areas.
- To minimize potential knit lines (particularly in components with two or more gates).
- To allow easy manual or automatic degating.
- To minimize flow path length (<150 L/T).

Hot Runner Manifold Systems

Hot runner tool designs are often used for GLS overmolding TPEs. As with conventional systems, the runner design should be naturally or geometrically balanced. All passages should have highly polished circular cross sections with gentle bends to minimize the possibility of stagnation zones. Externally heated manifolds are best. Internally heated systems, which use torpedo heaters, **are not recommended** because they have hot spots, stagnation zones and partially solidified material clinging to the walls.

Valve Gates

For hot runner tools, valve gates are recommended when production volumes are high and part appearance is critical. In parts that require stringent quality requirements, a valve gate will leave a ring that is barely visible on the surface of the part. After entering the cavity, the melt is not required to freeze before the valve is closed. Screw recovery can start immediately once the valve is closed, thus reducing the overall cycle time.

For very thick wall parts, with the potential for sinks or shrink voids, the valves are held open longer to allow for sufficient packing of the part. Valve gate elements need to be insulated from the mold plates to maintain proper temperature control. Due to the low viscosity of some GLS overmold grades, the pins need to be tight to prevent valve leakage or hair flash. Individual heater controls at each gate allow for finer control of the melt temperature and viscosity, as well as filling.

A valve gate can be located below the part surface or hidden in the part detail. Dependent on the size and thickness of the part, the gate diameter can vary between 0.030" and 0.125" (0.8 mm–3.2 mm).

Material Handling and Preparation

Drying

The moisture level of both the overmold grade as well as the substrate can adversely affect adhesion. It is critical that hygroscopic materials are dried prior to molding.

Drying is required for some specialty GLS TPEs, including Versollan™ Elastomer alloys. Drying should be done using a desiccant dryer with a dew temperature set at -40°F (-40°C). For the Versollan grades, a moisture level at or below 0.06% is recommended; typical drying conditions are 4 hours minimum at 120-140°F (50-60°C). Refer to the individual product technical data sheet for specific drying recommendations.

Coloring

When overmolding TPEs, care should be taken when considering color concentrates. While there are a variety of color concentrate carriers available, the adhesion of the TPE to the substrate can be seriously and even adversely affected if the carrier is incompatible with the chemistry of the TPE.

The most common color concentrate carrier is PP because it is compatible with many commercially available TPE products (for both single component molding and overmolding PP applications). As new TPE technologies emerge to adhere to engineering plastics like nylon and PC/ABS, PP-based color concentrates may not be the best choice for optimized adhesion characteristics. Instead, alternative carriers, such as EVA, LDPE or polyurethane may be required. Coloring suggestions for specific GLS overmolding products can be found in the individual technical data sheet.

Regrind

For insert molding applications, regrind may be used if clean, non-degraded TPE scrap is generated during the process (sprues and runners). Typical loading levels are 20%, however higher levels of regrind are tolerated in black color TPEs. Natural products, light colored or clear TPEs may show contamination or discoloration unless regrind cleanliness is properly controlled. When a high percentage of regrind is used, or there is a prolonged residence time in the barrel, organic pigments (used to produce yellow, red, blue and green colors) are more likely to discolor.

Regrind is not an option for most critical appearance two-shot molded components.

TPE Injection Molding

Material Flow Behavior

- Most GLS overmolding formulations have relatively low viscosity characteristics. They are shear responsive and their viscosity is reduced when they are processed at high shear rates. This helps them flow into and fill thin walled sections commonly encountered in overmolding.
- The shear thinning behavior of GLS TPEs should be considered when designing injection molds and optimization of molding conditions.

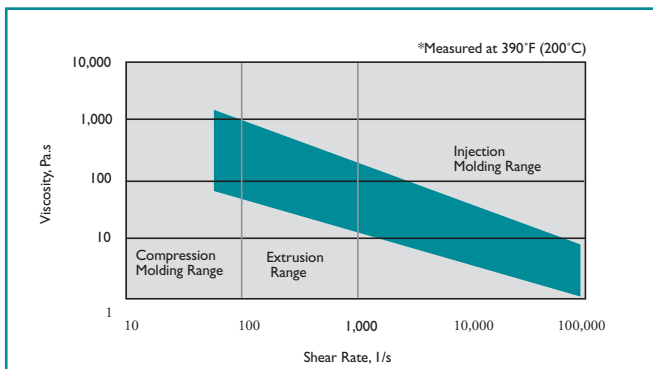

Figure 15. The effect of shear rate on the viscosity of GLS styrenic TPEs.

Figure 15 illustrates the range of viscosity of GLS overmolding TPEs. The lower end of the range is typical for most GLS TPEs. For the viscosity data of a specific TPE, refer to the individual product technical data.

Due to the shear sensitivity of TPEs, their injection molding process is slightly different than that of engineering thermoplastics. Unlike most thermoplastics, melt temperature alone is not the most effective method of controlling the TPE

molding process. Ideally, the goal is to obtain the lowest melt viscosity of the molten TPE through a combination of shear rate and temperature adjustments.

Shear rate in modern molding machines can be controlled through the use of:

- TPE melt velocity.
- First stage injection pressure.
- Smaller gate size.

General TPE Injection Molding Guidelines

The following are basic principles for optimizing the molding process for GLS TPEs:

- During start-up, the molding parameters should be set at the mid-point of the TPE supplier's recommendations.
- Shear rate adjustments should be the primary method used to control TPE melt viscosity. TPE melt temperature adjustments should only be used to fine-tune the process.
- To minimize shrinkage issues, adjust second stage pressure as necessary to insure the TPE melt is fully packed into the mold cavity.
- Utilize "cushion" properly during the mold filling process.

Machine Selection

Molding machines with conventional reciprocating screws are recommended. Computer controlled machines have the ability to better control critical molding parameters and are preferred for multi-cavity tools and high production quantities. Machines with programmable injection rates to “profile” the shot, and independent first and second stage pressures can produce better quality parts. This results in finished components with improved part weight and dimensional control. Older molding machines that control the shot size by position are preferable to machines that only control the process by pressure and/or time.

The clamp capacity necessary for general purpose GLS materials is 2-3 tons per square inch multiplied by the total projected area of the cavities and the runner system. This is lower than most other TPEs. If possible, use a machine that utilizes 25% to 75% of the barrel shot size capacity. This will result in better temperature control of the material and minimal material residence time at high temperature. The typical material residence time for GLS overmolding formulations should be no more than 4-5 minutes maximum. In most two-shot molding applications, the TPE shot size is considerably smaller than the plastic substrate shot size. If available, use an injection unit sized to minimize the TPE residence time.

During startup, choose a smaller nozzle diameter, which will help to produce shear heating during injection and generate less cold slug material. Suggested starting nozzle diameters are 1/16" to 3/16" (1.6 mm-4.8 mm). General-purpose (GP) screws are suitable for most GLS TPEs. Compression ratios between 2.0 and 3.0:1 will effectively control GLS overmolding TPEs during the injection molding process. Barrel/screw combinations should offer a minimum 24/1 L/D ratio.

Purging

If the press is idle for more than 10 minutes, purge thoroughly with a low flow (0.5-2.5 melt flow) polyethylene (PE) or polypropylene (PP) before restarting component production. To prevent flashing, restart the machine using a reduced shot size and gradually increase it to the previous setting.

Injection Pressure and Injection Speed

Typically, the required first stage injection pressure to fill a TPE cavity is 300 to 800 psi, depending upon the number of cavities and the mold runner layout. To achieve the benefits of shear-thinning, the injection speed should be adjusted to fill the mold in 1-3 seconds (varies with material). A higher shear rate can be readily achieved through greater TPE melt velocity (shot speed) and higher first stage injection pressure.

Mold Temperature

To prevent mold condensation and the resultant water contamination in the cavity, the mold temperatures should be set above the dew point temperature in the molding area. Mold temperatures may have to be increased if there are long or thin sections of the part that cannot be filled by adjusting other molding parameters. TPE mold temperatures of 70-120°F (21-49°C) are typical. Accurate mold temperature is critical when running molds with core lifters. When using these ejection systems, differential thermal expansion of the mold may cause the lifter to jam.

It is a common practice to use two mold temperature controllers while running GLS materials. If sticking in the A-half of the tool is an issue, reduce its temperature as a possible means of improving ejection performance.

Cooling Time

The required cooling time is dependent on the temperature of the melt, the wall thickness of the part and the quantity of cooling available. Harder grades will set up faster than softer grades and are easier to eject. Overmolded parts will take longer to cool because the TPE is only cooled from one side as the plastic substrate acts as a thermal insulator. The cooling time for overmolded parts will be approximately 15 to 40 seconds for every 0.100" (2.5 mm) of overmold wall thickness.

Given a final part design and TPE material selection, there are three primary variables that have an impact on cycle time:

- Diameter of cooling line.
- Geometric orientation (distance) of cooling line with respect to the tool cavity.
- Flow rate of the water through the cooling system.

Overmolding Processing — Maximizing Adhesion

Substrate Preparation and Molding

If insert molding is the process of choice, the preparation and molding of the insert can be critical to achieve optimal adhesion between the TPE and the substrate. If an insert surface is not clean, loss of adhesion between the TPE and substrate is a strong possibility. Ideally, it is best if the inserts are molded, then transferred immediately to the second mold to inject the TPE.

The insert should be molded in accordance with supplier recommendations (drying, adequate melt and mold temperatures). If the inserts are molded and stored prior to the overmolding phase of the process, they should be well-protected from contamination sources like dirt, dust, etc. Skin oil can also affect the TPE adhesion to the insert, so hand protection should be worn when handling the inserts. **Mold release should not be used** in either the insert or the overmolding processes, as the lubricants can seriously degrade the TPEs bond to the insert.

Studies have demonstrated that preheating the insert prior to overmolding can be very beneficial to the end quality of insert molded parts. The optimum insert temperature will vary, depending on both the insert material and the type of TPE used.

Preheating nylon inserts is strongly discouraged. The adhesion of the Versaflex™ OM 6100 series is outstanding, with no modification of the substrate. In fact, preheating the nylon insert can have a negative impact on adhesion.

TPE Melt Temperature

The TPE melt temperature is one of the most critical injection molding parameters for overmolding applications. A common practice is to equate nozzle temperatures with melt temperature. In many cases, this practice is misleading, since the real temperature of the melt can vary significantly from the nozzle's temperature. The size of the barrel, shot size and the calibration of thermocouples are all factors that can lead to inaccurate melt temperature readings.

The actual temperature of the melt can be best quantified by measuring the temperature of a TPE airshot using a pyrometer. In many cases, the melt temperature of the TPE is lower than the nozzle temperature. Correspondingly, lower melt temperatures can affect adhesion quality.

The melt temperature of the TPE must be selected based on the substrate used and target bond level desired in the finished component. To achieve optimal bond strength, higher temperatures using melt temperature guidelines for specific GLS products as a starting point is suggested. In some critical applications, this temperature can be close to the upper processing temperature limits for the TPE.

In order to reduce residence time at high temperatures, the rear zone temperatures should be reduced as much as possible, while maintaining the last zone and nozzle at the high processing temperature. For specific GLS overmolding TPEs, start-up temperature settings are included in the individual technical data sheet to assist molders to determine optimal melt temperatures.

Additional Factors that Affect Adhesion

- Grade of plastic substrate (glass-filled, mineral-filled, heat-stabilized, lubricated).
- The more polymer on the substrate surface, the better the adhesion.
- Ensure that the chosen TPE is designed to bond to the substrate.
- Appropriate TPE thickness — too thin can lead to delamination.
- Use of mechanical interlocks in the component design.
- Proper shut-off design.
- Adequate venting is critical, especially at ends of flow.
- Type of color concentrate carrier used in both the plastic and the TPE.
- Pre-drying of the TPE overmold material, if required.
- Substrate preparation and cleanliness.
- Higher TPE melt temperature generally provides higher bond strength.
- Control melt temperature by injection speed, 1st stage pressure, then barrel temps (to fine-tune).

TPE Injection Molding Troubleshooting

Problem: Beach marks and uneven shine

Possible Cause	Corrective Actions
High molecular weight formulations in highly polished mold.	<ul style="list-style-type: none"> • Adjust melt velocity and 1st stage injection pressure. • Change to a lower molecular weight formulation. • Consult with an Avient representative. • Texture mold cavity surface (EDM, sandblast, etc.).

Problem: Bubbles

Possible Cause	Corrective Actions
Melt temperature is too high (injection speed too fast).	<ul style="list-style-type: none"> • Lower melt temperature. • Lower injection speed.
Gas entrapment.	<ul style="list-style-type: none"> • Increase gate size.

Problem: Burned component edges (with short fill)

Possible Cause	Corrective Actions
Poor venting.	<ul style="list-style-type: none"> • Lower injection speed. • Add vents to mold design, 0.0005" - 0.008" (0.13 mm - 0.20 mm) deep. • Clean vents if clogged.

Problem: Burnt odor, parts have yellow cast

Possible Cause	Corrective Actions
Material degradation.	<ul style="list-style-type: none"> • Reduce TPE melt temperature (particularly in rear of machine). • Reduce residence time to 2 minutes maximum. • Reduce hot runner system melt temperature. • Minimize dead spots in hot runner manifold. • Purge barrel and hot runner. • Reduce regrind level to <15%.

Problem: Dimensions out of specification

Possible Cause	Corrective Actions
Improperly packed part.	<ul style="list-style-type: none"> • Check hold pressures (no drop). • Check that cushion was maintained.
Loss of control of shrinkage.	<ul style="list-style-type: none"> • Increase cooling time. • Check tool dimensions.

Problem: Ejector pin marks

Possible Cause	Corrective Actions
Pack pressure is too high.	<ul style="list-style-type: none">• Reduce pack pressure.
Parts are soft during ejection.	<ul style="list-style-type: none">• Increase cooling time.• Increase water flow rate in cooling time.
Ejection force is too high.	<ul style="list-style-type: none">• Reduce mold temperature.• Texture ejector pins and mold surface for better release.• Increase size of pins.• Consider use of pneumatic poppets to assist in component release.

Problem: Flash

Possible Cause	Corrective Actions
Injection pressure is too high.	<ul style="list-style-type: none">• Reduce 1st stage injection pressure and fill time.
Shot size is too high.	<ul style="list-style-type: none">• Decrease shot size.
Material viscosity is too low.	<ul style="list-style-type: none">• Reduce injection speed (melt velocity).• Reduce TPE melt temperature in 10°F/C increments.
Insufficient clamp capacity.	<ul style="list-style-type: none">• Increase machine clamp tonnage (min. 2 tons/sq. in.) with a larger press.
Vents are too deep.	<ul style="list-style-type: none">• Reduce thickness of the vents (max. 0.001" or 0.025 mm depth).

Problem: Flow marks, folds and back fills

Possible Cause	Corrective Actions
Melt temperature is too low.	<ul style="list-style-type: none">• Increase melt temperature.
Filling from thin to thick sections.	<ul style="list-style-type: none">• Reposition the gate to a thick section.
Surface irregularity.	<ul style="list-style-type: none">• Surface texture can be added to part design and steel wall cavities.
Uneven filling of section.	<ul style="list-style-type: none">• Relocate gate to balance the flow or reduce the runner diameter.

Problem: Heat sinks

Possible Cause	Corrective Actions
Material shrinkage.	<ul style="list-style-type: none">• Increase total cooling time.
Melt temperature is too high.	<ul style="list-style-type: none">• Reduce melt temperature.
Part is too thick in areas where sinks or voids occur.	<ul style="list-style-type: none">• Reduce part thickness.

Problem: Jetting

Possible Cause	Corrective Actions
High viscosity flow.	<ul style="list-style-type: none">• Increase TPE melt temperature.
Injection speed is too fast.	<ul style="list-style-type: none">• Decrease injection speed.
Incorrect gate location.	<ul style="list-style-type: none">• Relocate gate so that the melt impinges off wall as it enters cavity.

Problem: Non-uniform color

Possible Cause	Corrective Actions
Poor dispersion.	<ul style="list-style-type: none">• Ensure that proper color concentrate carrier is used.• Increase machine back pressure and/or screw RPM.• Change the color concentrate carrier to a material with a lower melt temperature.• Increase temperatures.
Contamination.	<ul style="list-style-type: none">• Purge barrel thoroughly.• Check for cleanliness of regrind.

Problem: Off-color part or odor

Possible Cause	Corrective Actions
Contamination.	<ul style="list-style-type: none">• Check for contamination in material handling and regrind (if used).
Material degradation.	<ul style="list-style-type: none">• Reduce TPE melt temperature (particularly in rear of machine).• Reduce residence time to 2 minutes maximum.• Reduce hot runner system melt temperature.• Minimize dead spots in hot runner manifold.• Purge barrel and hot runner.• Reduce regrind level to <15%.

Problem: Part sticks during ejection

Possible Cause	Corrective Actions
Pack pressure is too high.	<ul style="list-style-type: none">• Reduce pack/hold pressure.
Parts are too warm.	<ul style="list-style-type: none">• Increase total cycle time.• Reduce mold temperature.• Reduce TPE melt temperature.
Insufficient ejection force.	<ul style="list-style-type: none">• Increase number of ejector pins and increase diameter on larger components.• Consider use of pneumatic air poppets.• Reduce 2nd stage injection pressure.
Polished ejector sleeve finish.	<ul style="list-style-type: none">• Sandblast B side.

Problem: Part sticks in A-half or stationary side of tool

Possible Cause	Corrective Actions
Insufficient extraction force.	<ul style="list-style-type: none">• Sandblast A side.• Run A side cooler.• Increase draft on part in A-half of tool.

Problem: Short shots, no burn marks

Possible Cause	Corrective Actions
Not enough material.	<ul style="list-style-type: none">• Increase shot size, if possible.• Determine that machine barrel has enough capacity to fill TPE cavity.• Reduce RPM and back pressure.
TPE viscosity is too high.	<ul style="list-style-type: none">• Increase TPE injection speed (melt velocity).• Increase TPE melt temperature.
Insufficient injection force.	<ul style="list-style-type: none">• Increase 1st stage injection pressure.
Blockage at the feed-throat.	<ul style="list-style-type: none">• Decrease the barrel temperature in the rear.
Vents are blocked.	<ul style="list-style-type: none">• Inspect and clean vents, if required.

Problem: Splay/streaks, silver streaks

Possible Cause	Corrective Actions
High shear in the material.	<ul style="list-style-type: none">• Reduce injection speed.• Increase the TPE melt temperature.
Moisture in material (if hygroscopic).	<ul style="list-style-type: none">• Ensure that material is dried properly (check desiccant and dryer settings).
Contaminated material.	<ul style="list-style-type: none">• Check regrind for contaminants of moisture. Dry if required.• Purge barrel thoroughly.

Problem: Voids

Possible Cause	Corrective Actions
Insufficient pack pressure during material solidification.	<ul style="list-style-type: none">• Increase 2nd stage pressure and melt velocity.• Increase the gate size up to 40% of part wall thickness (max).• Relocate the gate to the thickest wall section.

Problem: Warped parts

Possible Cause	Corrective Actions
High molded-in stresses.	<ul style="list-style-type: none">• Increase cooling time.
Post-mold shrinkage.	<ul style="list-style-type: none">• Increase TPE melt temperature.• Reduce 2nd stage injection pressure.• Increase the mold temperature.

TPE Overmolding Troubleshooting

Problem: Flash (over substrate or on periphery of part)

Possible Cause	Corrective Actions
Poor mold fit.	<ul style="list-style-type: none"> • Check mold fit.
Inadequate molding machine tonnage.	<ul style="list-style-type: none"> • Increase machine tonnage to a minimum of 2 tons/in².
Improper TPE shut-off design.	<ul style="list-style-type: none"> • Recut tool to obtain complete shutoff with minimum 0.002" (0.05 mm) interference into substrate.
Substrate shrinkage/lack of supports.	<ul style="list-style-type: none"> • Check for substrate sinks and add substrate support.
Injection pressure is too high.	<ul style="list-style-type: none"> • Reduce 1st stage injection pressure and fill time.
Shot size is too high.	<ul style="list-style-type: none"> • Decrease shot size.
Material viscosity is too low.	<ul style="list-style-type: none"> • Reduce injection speed. • Reduce TPE melt temperature in 10°F/C increments.
Insufficient clamp capacity.	<ul style="list-style-type: none"> • Increase machine clamp tonnage (min. 2 tons/in²) with a larger press.
Vents are too deep.	<ul style="list-style-type: none"> • Reduce thickness of the vents (max. 0.001" or 0.025 mm depth).

Problem: Poor adhesion

Possible Cause	Corrective Actions
Injection speed is too slow and melt temperature is too low.	<ul style="list-style-type: none"> • Increase injection speed and melt temperature. • Reselect correct grade of GLS TPE to match plastic selected.
Contamination.	<ul style="list-style-type: none"> • Check for color concentrate compatibility.
Incompatible materials.	<ul style="list-style-type: none"> • Avoid lubricated plastic grade and do not use mold release spray.

Problem: Short shots

Possible Cause	Corrective Actions
Not enough material.	<ul style="list-style-type: none"> • Increase shot size, if possible. • Determine that machine barrel has enough capacity to fill TPE cavity. • Reduce RPM and back pressure.
TPE viscosity is too high.	<ul style="list-style-type: none"> • Increase TPE injection speed. • Increase TPE melt temperature.
Insufficient injection pressure.	<ul style="list-style-type: none"> • Increase 1st stage injection pressure.
Blockage at the feed throat.	<ul style="list-style-type: none"> • Decrease the barrel temperature in the rear.
Vents are blocked.	<ul style="list-style-type: none"> • Inspect and clean vents, if required.
Substrate shrinkage/lack of supports.	<ul style="list-style-type: none"> • Check for substrate sinks and add substrate support.

Problem: Overmold breaks/impinges through hollow substrate

Possible Cause	Corrective Actions
High injection pressure and melt temperature.	<ul style="list-style-type: none"> • Lower 1st stage injection pressure and reduce TPE melt temperature.
Substrate melting.	<ul style="list-style-type: none"> • Reduce melt temperature (injection speed). • Change substrate material.
Wrong location of gate.	<ul style="list-style-type: none"> • Relocate gate to the thickest TPE section. Avoid gating to thinnest wall area of substrate.
Improperly supported substrate.	<ul style="list-style-type: none"> • Fully support substrate.

Problem: Warped parts

Possible Cause	Corrective Actions
Post-mold shrinkage.	<ul style="list-style-type: none"> • Increase TPE melt temperature. • Increase TPE cooling time. • Increase the stiffness of the substrate by including glass or increasing thickness or ribs on substrate part structure.
The substrate is too thick compared to TPE overmold thickness.	<ul style="list-style-type: none"> • Design substrate thickness \geq TPE OM thickness.

Index

Adhesion	3-5, 21-22, 28	Burnt Odor	23
Balanced Runner Systems	10	Dimensions	23
Buttonhead Sprue Puller	13	Ejection	26
Cavity Layout	10	Ejector Pin Marks	24
Clamp Capacity	19	Flash	24
Cold Slug Wells	11	Flow Marks	24
Color Concentrate Carriers	17	Folds	24
Coloring	17	Heat Sinks	25
Conventional Sprue	12	Jetting	25
Cooling Time	20	Non-Uniform Color	25
Cushion	18	Off-Color Part	25
Cycle Time	6, 20	Short Shots	26
Delamination	7	Splay/Streaks	27
Diaphragm Gate	15	Uneven Shine	23
Direct Gate	14	Voids	27
Draft	6	Warpage	27
Drying Conditions	17	Yellow Parts	23
Edge Gate	13, 15	Injection Pressure	19
Ejection	9	Injection Speed	19
Fan Gate	14	Insert Molding	2-3, 10, 21-22
Flash	7-8, 24, 28	Insert Support	10
Flow Length	6	Jetting	13, 25
Flow Ratio	9	Land Length	11, 13-14
Fracture of Insert	29	Machine Selection	19
Gate Design	12-15	Material Flow Behavior	18
Gate Location	12-15	Material Handling and Preparation	17
Gate Size	12-15	Material Selection	4-5
Gate Types	12-15	Adhesion Requirements	5
Hot Runner Manifold Systems	16	Coefficient of Friction	4
Injection Molding	18-20	Durometer	4
Injection Molding Troubleshooting	23-27	Flexural Modulus	4
Back Fills	24	Substrate Type	5
Beach Marks	23	Thickness Effects	4
Bubbles	23	Melt Temperature	7, 18, 21-22
Burned Edges	23	Measuring	21

Mechanical Interlocks	8	Short-Shots.....	26, 29
Melt Viscosity	18	Shrinkage	7
Moisture		Shut-Off Designs	7-8
in Substrate	21	Shut-Off Groove	8
in TPE	17	Spiral Flow	6
Moisture Level	17	Sprue Gate	14
Mold Construction	9	Sprue Pullers.....	12-13
Mold Cooling	9, 19	Start-Up	18-19
Mold Design	9-16	Submarine Gate	14-15
Mold Layout	10	Substrate Molding	21
Mold Release.....	21	Substrate Preparation	21
Mold Support	10	Surface Defects	8
Mold Surface Texture	9	Surface Texture	8
Mold Temperature	19-20	Tab Gate	13
Multiple Material Molding	2-3	Texture	8
Multi-Shot Injection Molding.....	2-3	Tool Steel.....	9
Nylon, Preheating Inserts	21	Two-Shot Molding.....	2-3
Nozzle Diameter	19	Undercuts	6
Overmolding	2-3	Valve Gates	15-16
Part Design	6-8	Venting	10-11
Pin Gate	15	Viscosity.....	9, 18
Pine Tree Sprue Puller	12	Wall Thickness	6
Preheating Inserts	21	Warpage	27
Process Selection.....	3	Z-Type Sprue Puller	12
Process Types	2		
Purging	19		
Regrind.....	17		
Release Coating	9		
Residence Time	19		
Runner Configuration	11		
Runner Design	11		
Sharp Corners	6		
Shear Rate	18-19		
Shear Sensitivity.....	9, 18-19		
Shear Thinning.....	(see shear sensitivity)		

1.844.4AVIENT
www.avient.com



Copyright © 2020, Avient Corporation. Avient makes no representations, guarantees, or warranties of any kind with respect to the information contained in this document about its accuracy, suitability for particular applications, or the results obtained or obtainable using the information. Some of the information arises from laboratory work with small-scale equipment which may not provide a reliable indication of performance or properties obtained or obtainable on larger-scale equipment. Values reported as "typical" or stated without a range do not state minimum or maximum properties; consult your sales representative for property ranges and min/max specifications. Processing conditions can cause material properties to shift from the values stated in the information. Avient makes no warranties or guarantees respecting suitability of either Avient's products or the information for your process or end-use application. You have the responsibility to conduct full-scale end-product performance testing to determine suitability in your application, and you assume all risk and liability arising from your use of the information and/or use or handling of any product. AVIENT MAKES NO WARRANTIES, EXPRESS OR IMPLIED, INCLUDING, BUT NOT LIMITED TO, IMPLIED WARRANTIES OF MERCHANTABILITY AND FITNESS FOR A PARTICULAR PURPOSE, either with respect to the information or products reflected by the information. This literature shall NOT operate as permission, recommendation, or inducement to practice any patented invention without permission of the patent owner.